

TASCAM

TEAC Professional Division

FRONTIER

D00831000A

FW-1804

FireWire Audio-MIDI Interface

OWNER'S MANUAL

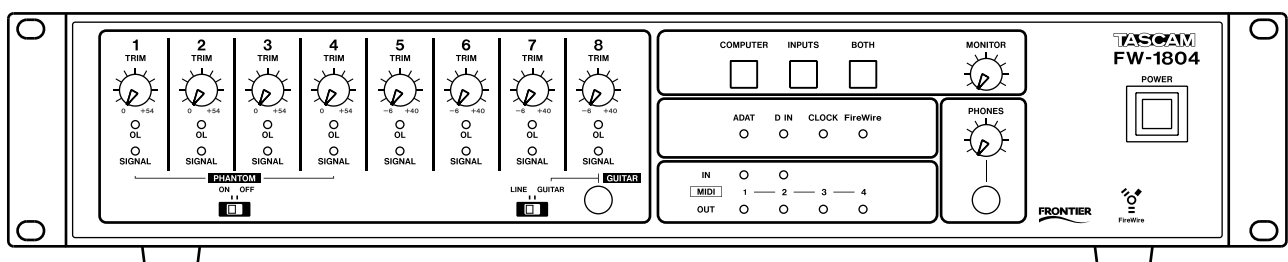

Important Safety Precautions



CAUTION: TO REDUCE THE RISK OF ELECTRIC SHOCK, DO NOT REMOVE COVER (OR BACK). NO USER-SERVICEABLE PARTS INSIDE. REFER SERVICING TO QUALIFIED SERVICE PERSONNEL.



The lightning flash with arrowhead symbol, within equilateral triangle, is intended to alert the user to the presence of uninsulated "dangerous voltage" within the product's enclosure that may be of sufficient magnitude to constitute a risk of electric shock to persons.



The exclamation point within an equilateral triangle is intended to alert the user to the presence of important operating and maintenance (servicing) instructions in the literature accompanying the appliance.

This appliance has a serial number located on the rear panel. Please record the model number and serial number and retain them for your records.

Model number _____
Serial number _____

WARNING: TO PREVENT FIRE OR SHOCK HAZARD, DO NOT EXPOSE THIS APPLIANCE TO RAIN OR MOISTURE.

For U.S.A.

TO THE USER

This equipment has been tested and found to comply with the limits for a Class A digital device, pursuant to Part 15 of the FCC Rules. These limits are designed to provide reasonable protection against harmful interference when the equipment is operated in a commercial environment. This equipment generates, uses, and can radiate radio frequency energy and, if not installed and used in accordance with the instruction manual, may cause harmful interference to radio communications.

Operation of this equipment in a residential area is likely to cause harmful interference in which case the user will be required to correct the interference at his own expense.

CAUTION

Changes or modifications to this equipment not expressly approved by TEAC CORPORATION for compliance could void the user's authority to operate this equipment.

For the customers in Europe

WARNING

This is a Class A product. In a domestic environment, this product may cause radio interference in which case the user may be required to take adequate measures.

Pour les utilisateurs en Europe

AVERTISSEMENT

Il s'agit d'un produit de Classe A. Dans un environnement domestique, cet appareil peut provoquer des interférences radio, dans ce cas l'utilisateur peut être amené à prendre des mesures appropriées.

Für Kunden in Europa

Warnung

Dies ist eine Einrichtung, welche die Funk-Entstörung nach Klasse A besitzt. Diese Einrichtung kann im Wohnbereich Funkstörungen verursachen ; in diesem Fall kann vom Betreiber verlangt werden, angemessene Maßnahmen durchzuführen und dafür aufzukommen.

CE Marking Information

- a) Applicable electromagnetic environment: E4
- b) Peak inrush current: 4.6 A

Important Safety Instructions

- 1 Read these instructions.
 - 2 Keep these instructions.
 - 3 Heed all warnings.
 - 4 Follow all instructions.
 - 5 Do not use this apparatus near water.
 - 6 Clean only with dry cloth.
 - 7 Do not block any ventilation openings. Install in accordance with the manufacturer's instructions.
 - 8 Do not install near any heat sources such as radiators, heat registers, stoves, or other apparatus (including amplifiers) that produce heat.
 - 9 Do not defeat the safety purpose of the polarized or grounding-type plug. A polarized plug has two blades with one wider than the other. A grounding type plug has two blades and a third grounding prong. The wide blade or the third prong are provided for your safety. If the provided plug does not fit into your outlet, consult an electrician for replacement of the obsolete outlet.
 - 10 Protect the power cord from being walked on or pinched particularly at plugs, convenience receptacles, and the point where they exit from the apparatus.
 - 11 Only use attachments/accessories specified by the manufacturer.
 - 12 Use only with the cart, stand, tripod, bracket, or table specified by the manufacturer, or sold with the apparatus. When a cart is used, use caution when moving the cart/apparatus combination to avoid injury from tip-over.
- Do not expose this apparatus to drips or splashes.
 - Do not place any objects filled with liquids, such as vases, on the apparatus.
 - Do not install this apparatus in a confined space such as a book case or similar unit.
 - The apparatus draws nominal non-operating power from the AC outlet with its POWER switch in the off position.



- 13 Unplug this apparatus during lightning storms or when unused for long periods of time.
- 14 Refer all servicing to qualified service personnel. Servicing is required when the apparatus has been damaged in any way, such as power-supply cord or plug is damaged, liquid has been spilled or objects have fallen into the apparatus, the apparatus has been exposed to rain or moisture, does not operate normally, or has been dropped.

Contents

Introduction	5
Overview	5
Features	5
System Requirements	5
In the Box	6
Rack-mounting the Unit	6
Nomenclature Used in the Manual	6
Copyright, etc.	6
Parts of the FW-1804	7
Front Panel	7
Rear Panel	9
Monitor Mixing	10
Setting and Checking Clock Rates	10
Monitor Mixing	10
Monitoring Setups	10
Making Mixer Settings	10
Setting Input Levels	11
Control Panel	12
Settings Tab	12
Routing Tab	12
Quick Start Tab (Windows only)	13
Core Audio Tab (Mac OS X only)	13
Troubleshooting	14
Specifications	15

Overview

Thank you for choosing the TASCAM FW-1804. We have designed the FW-1804 to be an ideal audio/MIDI interface for your computer-based digital audio workstation system. Its integrated design incorporates a high-resolution professional multi-channel audio interface and integrated zero-latency input monitor mixer and a 2 x 4 MIDI interface.

Please take some time to look through this owner's manual and familiarize yourself with the FW-1804's features and operation. We suggest you pay particular attention to the operational notes for your software application(s) of choice. You may also want to refer to your software's documentation in many cases, for a clear understanding of how to configure device drivers. Your experience with the FW-1804 will be greatly enhanced by a good working knowledge of your audio software.

Features

The audio input section is fully 24-bit and can accommodate sample rates of up to 96 kHz. It is capable of inputting up to eighteen simultaneous channels of audio (eight analog, eight ADAT digital and two S/PDIF digital) to your computer. It features eight analog inputs, four with professional quality microphone preamps and switchable phantom power, as well as eight line inputs and four analog channel inserts. Digital inputs are available in an S/PDIF coaxial configuration and an ADAT optical configuration.

The output section offers two balanced line level analog outputs. A stereo S/PDIF coaxial digital output and eight channel ADAT optical output are also featured.

The FW-1804 is supported under Windows XP and Windows 2000, Mac OS X 10.2.8 (Jaguar) or later and Mac OS 9.2.2 or later. In addition, your computer must be fitted with a 6-pin IEEE 1394 (FireWire™) interface.

NOTE

Some manufacturers may use a different nomenclature to refer to their FireWire™ connections, such as Sony's "i.LINK", or simply "1394".

The FW-1804 comes with a high-quality 6-pin to 6-pin interface cable. We strongly suggest you use this cable, or one of equal quality, for optimum audio performance. We always recommend the use of a 6-pin IEEE 1394 connector (not the 4-pin type) on your computer.

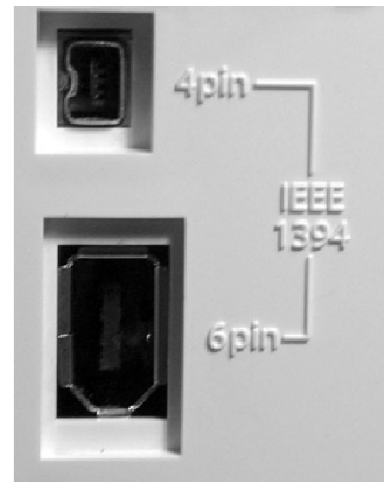

The FW-1804 is supplied with a 2 m (6-foot) cable. If you wish to use a longer cable, the length should not be more than 4 m (13 feet) and the cable should be the best possible quality available to avoid data loss, which results in audio dropouts.

CAUTION

- We strongly suggest that although a "daisy-chain" connection is provided, that the FW-1804 is the only unit connected to the FireWire port.
- Always perform all FireWire connections and disconnections with the power to both the FW-1804 and the computer turned off. If connections are made or broken with power to the FW-1804 or computer turned on, this may result in your computer crashing, or "freezing" and possible loss of data.
- When turning the power of the FW-1804 on and off when it is connected to the computer, turn on the power before launching the DAW software, and quit the software before turning off the FW-1804.

System Requirements

The FW-1804 is supported under Windows XP and Windows 2000. The FW-1804 is not supported under Windows 98 or Windows ME.

In the case of Windows 2000, you must be running SP3 or SP4 and then use the supplied installer which includes the Hotfix. Windows 2000 SP5 includes the Hotfix, so the FW-1804 driver installer only may be used. For Windows XP, you must be running SP1 and then use the supplied installer which includes the Hotfix. Windows XP SP2 includes the Hotfix, so the FW-1804 driver installer only may be used.

On the Mac, the FW-1804 is supported under Mac OS X version 10.2.8 or later and Mac OS 9.2.2. Earlier versions of Macintosh operating systems are not supported.

Introduction

In the Box

The FW-1804's box contains the items listed below. When opening the package please be certain all the items listed are included. If any items are missing, please consult your TASCAM dealer.

- FW-1804
- AC power adapter (PS-1225) and cable
- AC plug adapter (for Japan and Asia only)
- IEEE 1394 6-pin to 6-pin cable
- A CD-ROM containing the driver and utility software and documentation for the FW-1804 (Windows and Mac compatible)
- A CD-ROM containing the Cubase LE application
- Rack-mounting kit
- This manual
- The *Setup Guide*
- Warranty card

WARNING

When using the FW-1804, only use the PS-1225 power adapter and cable supplied. Do not use this power adapter and cable with any other product.

Rack-mounting the Unit

Use the rack-mounting kit to mount the unit in a standard 19-inch equipment rack, as shown below.

- Remove the feet of the unit before mounting it.
- Leave 1U of space above the unit for ventilation.
- Allow at least 10 cm (4 in) at the rear of the unit for ventilation.

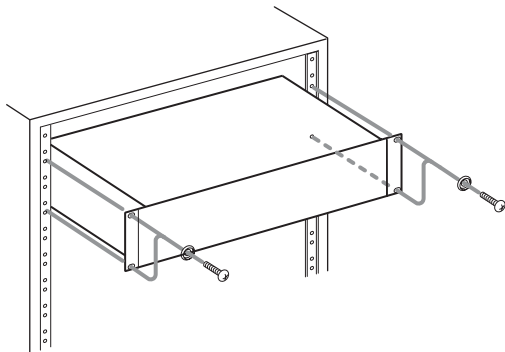

Nomenclature Used in the Manual

Within this manual, the following typographic conventions are used:

- The name of a control or connector on the unit is written in the following way: **LINE/MIC**.
- The name of a control or connector on another unit is written in the following way: **AUX IN**.
- When referring to the screen display of the host computer, we refer to any prompts, messages, etc. in the following typeface: **Press any key to continue**.
- If you have to type something into the computer, we write it this way: **FILENAME.EXT**.
- The names of keys to be pressed on the computer keyboard are written in this typeface with square brackets enclosing them **[F1]**.
- Keys that are to be pressed together are joined by a + symbol, so that **[Ctrl]+[F1]** means "press and hold the Control key and press the F1 key".
- Whenever we refer to the software application to control and set up the FW-1804, we refer to it as the "Control Panel" or the "software Control Panel".

Copyright, etc.

Windows, Windows XP, and Windows 2000 are trademarks of Microsoft Corporation.

Macintosh, Mac OS, Mac OS X and FireWire™ are trademarks of Apple Computer.

i.LINK is a trademark of Sony Corporation.

All other trademarks are the property of their respective holders.

Front Panel

The FW-1804 front panel is conveniently grouped into logical areas.

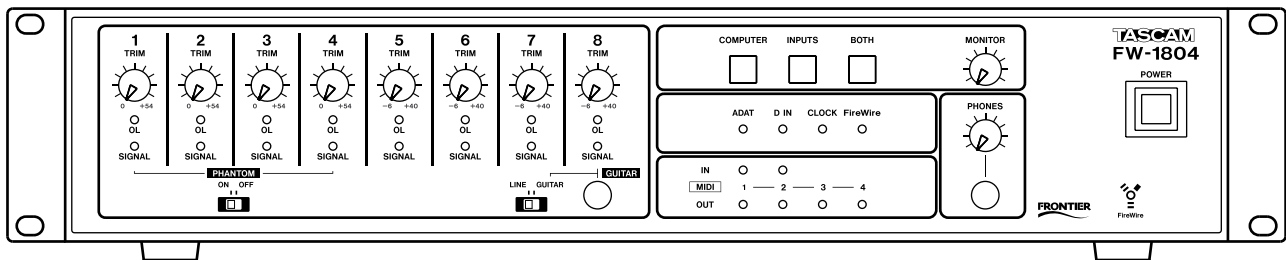

Input Section

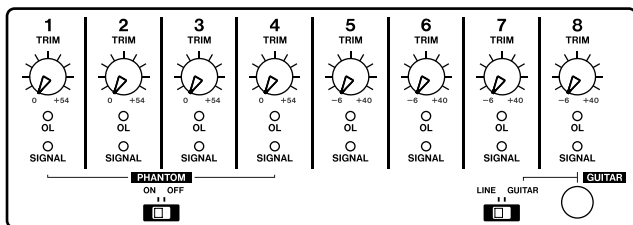

TRIM controls

Analog level controls for the input level of the mic (XLR) inputs 1 through 4, and line inputs 1 through 8. Their function is the same regardless of the monitor mode selected. Note that the best signal-to-noise ratios are achieved by maximizing the level of analog inputs at the A/D converters. For the mic and line inputs of the FW-1804, the **TRIM** controls provide the means for optimizing these levels.

OL indicators

The OL indicators light to indicate a signal peaking at -2.5dBFS or higher by default (this level is adjustable between 0.0 dBFS and 5.0 dBFS , in 0.5 dB increments, using the FW-1804's software Control Panel). When one of these indicators lights, it indicates an overloaded input—reduce the level of the input to the channel until the indicator goes out.

SIGNAL indicators

The SIGNAL indicators light to indicate the presence of an audio signal at the corresponding analog input. These indicators light when the signal level is -42 dBFS or higher.

These indicators and the OL indicators indicate signal levels to the eight analog inputs regardless of the monitor mode selected.

PHANTOM switch

Use this switch to enable phantom power for the microphone jacks.

CAUTION

Microphones should not be connected to or disconnected from the FW-1804 with phantom power switched on. Unbalanced dynamic microphones should never be connected to phantom-powered connectors.

GUITAR/LINE switch

Affects **LINE IN 8** only. When this is set to **GUITAR**, the input impedance then matches that of an electric guitar or passive bass. For all other instruments, leave this in the **LINE** position.

Indicators

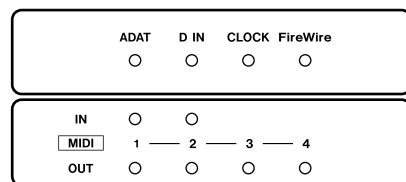

ADAT indicator

This indicator lights when a valid clock signal in ADAT format is received.

D IN indicator

This indicator lights when a valid clock signal in S/PDIF or TOSLINK format is received.

CLOCK indicator

This indicator lights when the internal clock is locked to the selected sampling frequency.

FireWire indicator

This indicator lights when a valid IEEE 1394 (FireWire) connection is made between the FW-1804 and the host computer.

MIDI IN and OUT indicators

These light momentarily when MIDI activity is detected on the appropriate port(s). These indicators function independently of the monitor mode.

Parts of the FW-1804

Monitoring and Phones

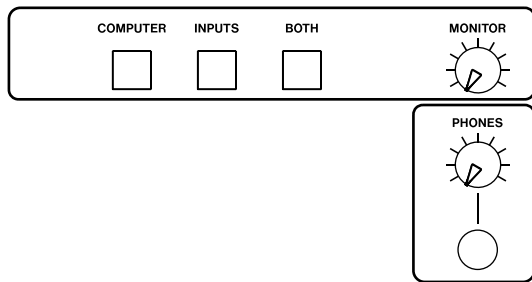

COMPUTER / INPUTS / BOTH keys

These keys select the source of the signal being sent to the balanced stereo analog outputs.

COMPUTER: Only the audio from the host computer is monitored. This can be useful if you're doing a mixdown of your DAW tracks and want to mute the monitor mixer without losing its settings.

INPUTS: Only the audio from the FW-1804's analog, ADAT and S/PDIF inputs is monitored. This can be useful for setting up live inputs or tracking into your DAW.

BOTH: The audio signals from the host DAW and the FW-1804's inputs are monitored.

MONITOR control

This analog control affects the level of the signal sent from the balanced 1/4" **STEREO OUT (BAL)** outputs.

PHONES control

This analog control affects the level of the signal sent from the stereo **PHONES** jack.

PHONES jack

Headphone level output from a stereo 1/4" jack.

POWER Switch

Make sure the switch is off when making the power connection.

NOTE

Wait more than five seconds before you turn on the FW-1804 just after you turned it off. Otherwise, the FW-1804 may not be started up normally.

WARNING

The FW-1804 outputs produce a "thump" when the power is turned on.

To avoid any damage to hearing or equipment, turn the volume of the monitoring system down, or make sure it is turned off, and do not wear headphones connected to the FW-1804 when powering the unit on or off.

Rear Panel

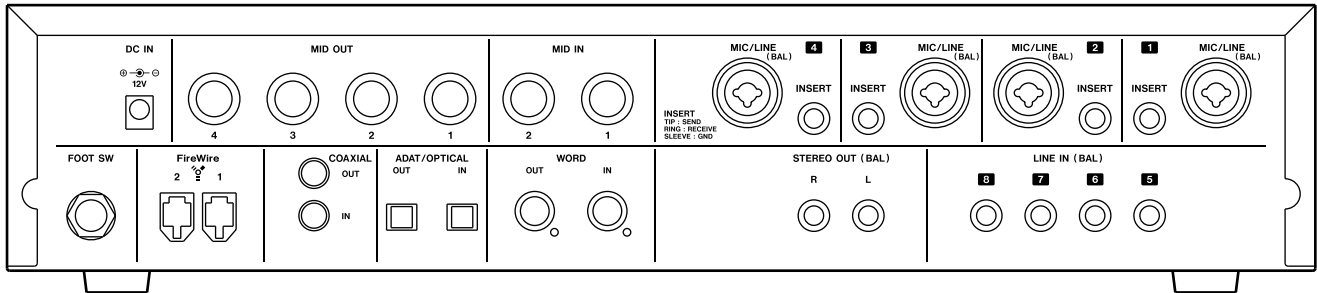

DC IN jack

Connect only the power adapter supplied with your FW-1804 to this jack.

Make sure the **POWER** switch is off when making the power connection.

MIDI IN/OUT connectors

Two MIDI IN and four MIDI OUT connectors allow you to hook up MIDI controllers, etc. as well as external tone generator modules, etc.

MIC/LINE jacks (1-4)

XLR-TRS combo jacks to input microphones or line level sources. The XLR connectors (1: ground, 2: hot, 3: cold) are connected to internal microphone pre-amplifiers. The TRS (tip: hot, ring: cold, sleeve: ground) jacks are balanced line level (+11 dBu) analog inputs. These use concentric jacks so only one source, a mic or a line source, can be connected.

CAUTION

Microphones should not be connected to or disconnected from the FW-1804 with phantom power switched on.

Unbalanced dynamic microphones and some ribbon microphones should never be connected to phantom-powered connectors. Check with your microphone manufacturer if you are unsure.

INSERT jacks (1-4)

Individual channel inserts. These are 1/4" TRS (tip: send, ring: receive, sleeve: ground) jacks which allow you to insert an external processor, such as an analog compressor, into the signal chain for inputs 1 to 4 (mic or line). The insert point is placed between the input (after the mic/line trim) and the analog-to-digital converter. A standard insert "Y" cable with a TRS plug is required. Check with your music retailer.

LINE IN jacks (5-8)

Balanced line level (+4 dBu) 1/4" TRS (tip: hot, ring: cold, sleeve: ground) analog inputs.

STEREO OUT (BAL) L & R jacks

Two balanced +4 dBu line-level outputs on 1/4" TRS jacks (tip: hot, ring: cold, sleeve: ground).

WORD IN connector

Coaxial BNC connector for input of external Word Clock signal from another device. This input is 75 ohm terminated.

WORD OUT connector

Coaxial BNC connector for output of the FW-1804's Word Clock signal to another device.

ADAT/OPTICAL IN/OUT connectors

Fiber-optic input/output to accommodate eight-channel ADAT format or two-channel S/PDIF in TOSLINK format.

COAXIAL IN/OUT connectors

S/PDIF coaxial digital input and output using RCA (pin) connectors.

FireWire ports

Use one of these ports to connect the FW-1804 to the host computer, providing audio communication. Either port may be used to connect the FW-1804 to your computer.

FOOT SW jack

Accommodates a standard momentary foot switch through a 1/4" jack. The function of this jack is assigned in the software control panel.

Monitor Mixing

Setting and Checking Clock Rates

The FW-1804's audio clock rate and source are checked or changed from the software Control Panel.

Expected Sample Rate

If a digital input is selected as the clock source and it does not have a usable clock signal, the **CLOCK** indicator flashes to indicate a problem, and the unit switches to its own internal clock and waits for a valid clock signal. If the sample rate is off by 3% or more, the FW-1804 switches to the internal clock.

Monitor Mixing

The FW-1804 has a hardware monitor mixer which is controlled by a software mixer window accessed from the software Control Panel. The primary benefit of this is to provide a means of monitoring your audio inputs in a zero-latency environment.

By using the monitor mixer to monitor the audio at the inputs along with the audio return from your DAW application, it is possible to overdub tracks to your DAW software with none of the audio processing delays inherent in DAW applications.

Monitoring Setups

The source of the signal being sent to the balanced stereo analog outputs is dependent on which of the three keys is selected: **COMPUTER**, **INPUTS** or **BOTH**.

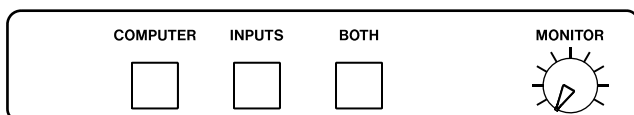

COMPUTER key

Only the audio from the host computer is monitored. This can be useful if you're doing a mixdown of your DAW tracks and want to mute the monitor mixer without losing its settings.

INPUTS key

Only the audio from the FW-1804's analog, ADAT and S/PDIF inputs is monitored. This can be useful for setting up live inputs or tracking into your DAW.

BOTH key

The audio signals from the host DAW and the FW-1804's inputs are monitored.

- The default setting is **BOTH**.

Making Mixer Settings

Once the monitor setup has been made, it is possible to use the software mixer interface to set the levels and pan position. Click the **Show Mixer** button on the **Settings** tab of the Control Panel.

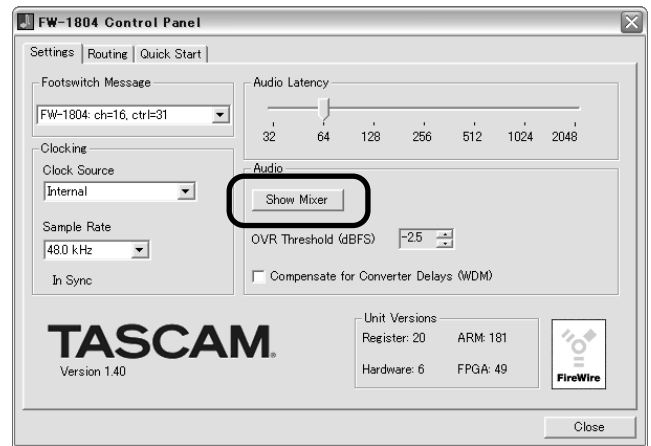

The following screen will appear:

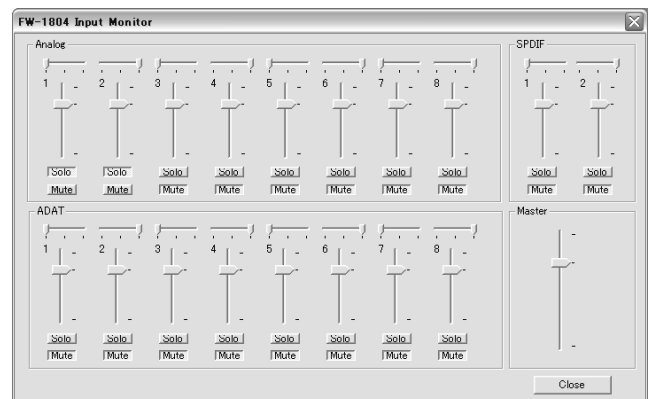

Setting the master fader to 0 dB (unity gain)

Hold **[Shift]** and click the master fader.

Setting a channel's monitor level to 0 dB (unity gain)

Hold **[Shift]** and click the channel fader.

NOTE

It is important to understand that when using the monitor mixer, the FW-1804's software mixer interface is controlling the monitor levels of the FW-1804's input sources. While you will still hear the audio returns from your DAW, moving the faders in the FW-1804's software monitor mixer has no effect on your DAW's internal mixer.

Another important point to note is that monitor mixer's faders do not affect the levels of the inputs sent to your DAW. The levels to the DAW inputs from analog inputs 1 through 8 are controlled solely by their respective **TRIM** controls. The digital inputs are passed to your DAW application at unity gain; their level must be regulated at the digital source.

Setting Input Levels

The FW-1804 can be very useful for recording live tracks into a DAW application. Here's a typical scenario for recording and overdubbing using the FW-1804:

- 1** Connect your analog and/or digital source(s) to the FW-1804's inputs.
- 2** Access the monitor mixer's software interface.
- 3** Press the **INPUTS** key to monitor the inputs without hearing your existing DAW tracks.
- 4** Adjust the channel's **TRIM** control (if it is an analog input) or the digital source (if it is a digital input) until the input meter in your DAW shows a level that is hot, but not clipping.
- 5** Repeat this procedure for all active input channels.

Once you're done setting up levels, you can return to **COMPUTER** monitor mode and begin recording.

Control Panel

The FW-1804's Control Panel is where you can display and adjust settings which determine how the FW-1804 communicates with your computer and other external devices. To open the Control Panel:

Windows: Click on **Start** -> **Control Panel** and selecting the **FW-1804 Control Panel** icon.

OS X: The **FW-1804 Manager** can be found in **Applications**.

OS 9: The **FW-1804 Control Panel** can be found in **Control Panels**.

There are three tabs on the Control Panel: **Settings**, **Routing**, and **Quick Start**. Under Mac OS X, **Core Audio** tab is in place of **Quick Start**.

Settings Tab

This is where you make the basic settings to configure the FW-1804.

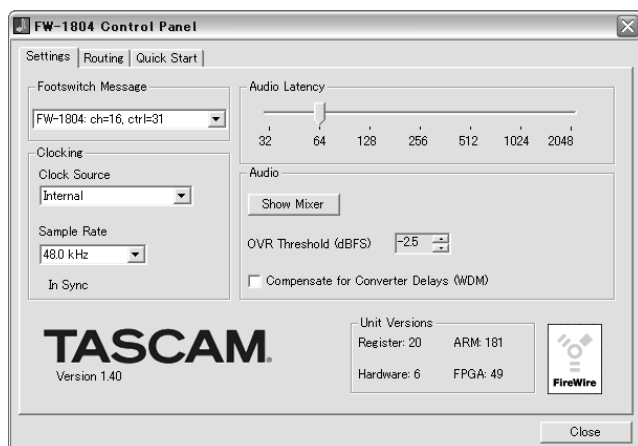

Footswitch Message

This is where you select how the FW-1804's footswitch command is interpreted by the host software application. You can choose between FW-1804 Native or Mackie Control emulation protocol.

Clock Source

This is where you can select the digital clock source.

Sample Rate

This is where you select the expected sample rate to the FW-1804's digital inputs and the internal sampling frequency.

Audio Latency

This setting is for selecting the buffer size of the FW-1804's audio performance. The FW-1804's driver temporarily stores input and output audio samples in buffers. Larger buffer sizes will produce higher latencies but will result in

greater system stability, and protection against other system activities causing clicks, pops and other audio artifacts. Some experimentation is always required to find the best balance between latency and stability.

OVR Threshold

This setting determines the level at which the FW-1804's **OL** indicators register an "over," or clipping level. It can be varied between 0.0 and -5.0 dBFS, in .5 dBFS increments.

Compensate for Converter delays (WDM)

This setting (Windows only) allows WDM drivers to compensate for converter delays.

Routing Tab

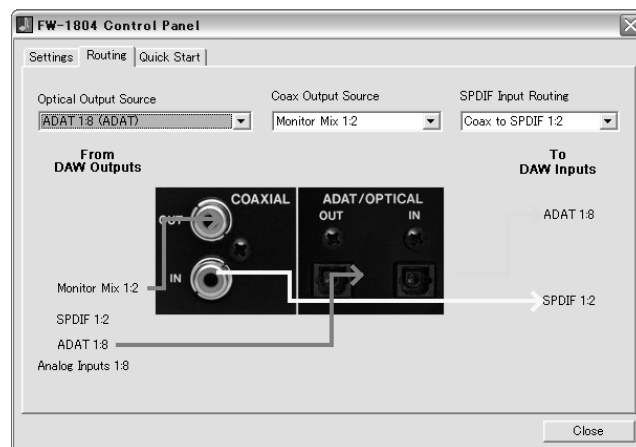

Optical Output Source

This menu selects the source of the audio output appearing at the FW-1804's ADAT optical outputs. The selections are:

ADAT 1:8 - The audio output is determined within your DAW application. Audio which has been routed to the FW-1804's ADAT outputs within your DAW will appear at the ADAT lightpipe output.

Duplicate of Coax Output (TOS) - The audio output is the same as that being sent to the FW-1804's analog outputs **L** and **R**, and is sent out the lightpipe in two-channel TOSLINK protocol. This can be useful for sending a two-track mix to a mixdown recorder equipped with an optical two channel input.

Analog Inputs 1:8 - The signal present at the eight analog inputs is routed directly to the ADAT outputs. This is useful in the event you have an analog source that needs to be input to another device that only has ADAT inputs.

Coax Output Source

This menu selects the source of the audio output appearing at the FW-1804's coaxial digital output. The selections are:

SPDIF 1:2 - The audio output is determined within your DAW application software. The FW-1804's S/PDIF outputs are seen as separate outputs within your DAW application. With this setting, audio which has been routed to these outputs appears at the FW-1804's two-channel digital outputs.

Monitor Mix 1:2 - The audio output is identical to that being sent to the FW-1804's **STEREO OUT**. This is useful if, for example, you wish to send the stereo mix you are monitoring to a two channel digital mixdown recorder. Note that the **MONITOR** control does not affect the coaxial output in this case.

SPDIF Input Routing

This menu selects the source of the audio input appearing at the FW-1804's two-channel digital (D IN) inputs. The selections are:

COAX to SPDIF 1:2 - The digital audio signal being input to the FW-1804's coaxial digital input is routed to the two-channel digital (D IN) inputs.

Optical to SPDIF 1:2 - A two-channel digital audio signal in TOSLINK format, being input to the FW-1804's optical digital input, is routed to the two-channel digital (D IN) inputs. (Note that the ADAT inputs will not be available to your DAW application if you use the optical input connector in TOSLINK mode.)

Quick Start Tab (Windows only)

This allows you to specify a set of channels which will always stream when using WDM/KS Driver Mode in SONAR.

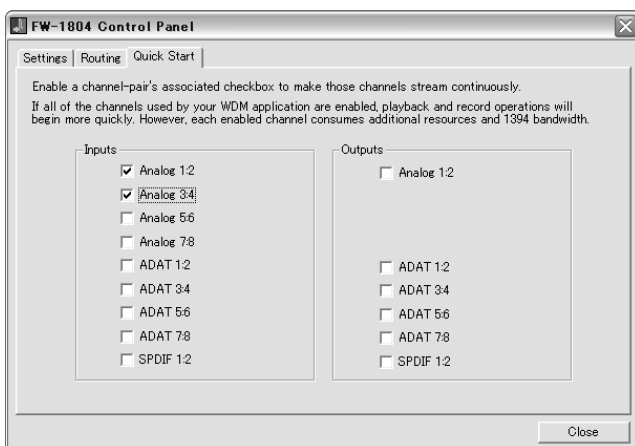

This, for example, speeds up the start of a playback or record operation in SONAR, especially when there are a lot of channels enabled. If there is a hesitation after pressing **PLAY** or **RECORD** before the operation begins, try enabling this feature.

To use it, check the channels that you will be using in your WDM audio app. When the channels selected in the **Quick Start** tab match the channels actually used by your application, the FW-1804 will not have to re-sync when the application begins to use those channels. This has shown to be much faster, and less prone to produce an "audio engine stop" message.

Core Audio Tab (Mac OS X only)

In OS X, you can specify how the FW-1804 should appear to the operating system:



The options available are as follows:

An 18-Input/12-Output Sound Device

All input and output channels are used. The S/PDIF input channels become channels 17 and 18, and the S/PDIF output channels become two output channels in addition to the ADAT and monitor outputs.

An 8-Channel Sound Device

Select either the analog input channels or the ADAT input channels. The outputs are the analog monitor outputs or the ADAT outputs. Note that the ADAT output level is not controlled by the front panel **MONITOR** control.

A 2-Channel (Stereo) Sound Device

Select any pair (1-2, 3-4 etc.) of inputs as the input pair. Select any pair of outputs as the output pair. Note that only the stereo analog outputs are controlled by the front panel **MONITOR** control.

TIP

In order to optimize the load on your CPU, you should configure the FW-1804 for your situation. If you are making a live stereo recording using the FW-1804, there is little point in configuring an 18-in/12-out device, for example.

Troubleshooting

The FW-1804 is a high performance audio device that must be set up correctly to work with a computer or other audio devices. If you experience problems with your FW-1804, here are a few suggestions to check first:

I hear no sound.

Do you have a valid audio signal appearing at the FW-1804's output bus? Check your output connections and monitoring system.

Do you have the correct monitor source selected?

If your audio source is an analog input:

Is the channel trim control adjusted correctly?

If your audio source is a condenser microphone:

Do you have phantom power enabled?

If your audio source is a digital input:

Do you have a valid digital source connected?

Are the correct clock settings selected?

If your audio source is your DAW application:

Do you have the correct outputs selected within the host application?

If you're running Windows 2000 or Windows XP:

Does the FW-1804 appear as an audio device in Device Manager? Is the Device Manager free of yellow marks?

My audio is distorted.

Is your input level too hot (**OL** indicators lighting)?

My audio has clicks and pops.

Do you have the correct clock source selected?

Is the latency set too low?

Contacting Us

In the event of any problems with your FW-1804, please contact your dealer or your local TEAC/TASCAM distributor.

Contact information may be found at the back of this manual, or on the TASCAM Web site.

Analog I/O

MIC input 1-4 (Balanced)

Connector	XLR 3-31 (combo jack) x 4 (1: GND, 2: Hot, 3: Cold)
Input impedance	2.0 k ohm
Adjustable input range	-57 dBu (TRIM max) to -3 dBu (TRIM min)
Maximum input level	+13 dBu
Phantom power	Switchable +48 V

LINE input 1-4 (Balanced)

Connector	1/4 inch TRS (combo jack) x 4 (T: Hot, R: Cold, S: GND)
Input impedance	10 k ohm
Adjustable input range	-43 dBu (TRIM max) to +11 dBu (TRIM min.)
Maximum input level	+27 dBu

LINE input 5-8 (Balanced)

Connector	1/4 inch TRS jack x 4 (T: Hot, R: Cold, S: GND)
Input impedance	15 k ohm
Adjustable input range	-42 dBu (TRIM max) to +4 dBu (TRIM min.)
Maximum input level	+20 dBu

GUITAR input (Input 8, Unbalanced)

Connector	1/4 inch TS jack (T: Hot, S: GND)
Input impedance	680 k ohm
Adjustable input range	-44 dBu (TRIM max) to +2 dBu (TRIM min.)
Maximum input level	+18 dBu

INSERT 1-4 (Unbalanced)

Connector	1/4 inch TRS jack x 4 (T: Send, R: Return, S: GND)
-----------	--

Send

Output impedance	100 ohm
Nominal output level	-2 dBu
Maximum output level	+14 dBu

Return

Input impedance	100 k ohm
Nominal input level	-2 dBu
Maximum input level	+14 dBu

STEREO OUT L, R (Balanced analog)

Connector	1/4 inch TRS jack x 2 (T: Hot, R: Cold, S: GND)
Output impedance	100 ohm
Nominal output level	+4 dBu
Maximum output level	+20 dBu

PHONES output (Stereo)

Connector	1/4" stereo jack (T: L, R: R, S: GND)
Max output power	50 mW + 50 mW (32 ohm)

Digital I/O

COAXIAL input

Connector	RCA jack x 1
Input impedance	75 ohm
Format	IEC60958
Audio bit length	24-bit

COAXIAL output

Connector	RCA jack x 1
Output impedance	75 ohm
Format	IEC60958
Audio bit length	24-bit

Specifications

ADAT/OPTICAL input

Connector	Lightpipe
Format	ADAT/IEC64958
Audio bit length	24-bit

ADAT/OPTICAL output

Connector	Lightpipe
Format	ADAT/IEC64958
Audio bit length	24-bit

Misc. I/O

MIDI IN 1-2

Connector	5-pin DIN x 2
Format	MIDI

MIDI OUT 1-4

Connector	5-pin DIN x 4
Format	MIDI

WORD IN

Connector	BNC x 1
Input impedance	75 ohm
Input level	TTL level

WORD OUT

Connector	BNC x 1
Output impedance	75 ohm
Output level	TTL level

FireWire (IEEE1394)

Connector	IEEE1394 connector x 2
Format	IEEE1394
Transmit rate	400 Mbps

FOOT SW (foot switch)

Connector	Normally-open 1/4" TS jack x 1
Input level	TTL level

Overall System Specifications

Sampling frequency

Internal clock	44.1 kHz / 48.0 kHz / 88.2 kHz / 96.0 kHz
External clock	Word sync input / Digital input / ADAT input

Analog Performance

THD (at maximum input level)

< 0.007% (normal FS)	1 kHz, MIC/LINE IN to STEREO OUT
< 0.009% (Hi FS)	1 kHz, MIC/LINE IN to STEREO OUT

Frequency response (at nominal level)

20 Hz - 20 kHz (normal FS)	+0.5 dB/-1.0 dB, MIC/LINE IN to STEREO OUT
20 Hz - 40 kHz (Hi FS)	+0.5 dB/-1.5 dB, MIC/LINE IN to STEREO OUT

S/N ratio

> 97 dB (normal FS)	MIC/LINE IN to STEREO OUT, TRIM min
> 91 dB (Hi FS)	MIC/LINE IN to STEREO OUT, TRIM min

Crosstalk

> 90 dB (normal FS)	1 kHz, MIC/LINE IN to STEREO OUT
> 84 dB (Hi FS)	1 kHz, MIC/LINE IN to STEREO OUT

Physical, etc. Specifications

Power requirements

Power adapter AC input 100V AC, 50/60 Hz
 120V AC, 60 Hz
 230V AC, 50 Hz
 240V AC, 50 Hz

Adapter output voltage 12 V, 2.5 A

Power consumption 19.5 W

Dimensions (w x h x d) 483 x 95 x 356 (mm) (19" x 3.75" x 14")

Weight (excluding adapter) 5.7 kg (12.6 lb)

Dimensional Drawing

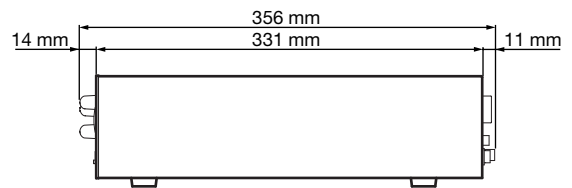
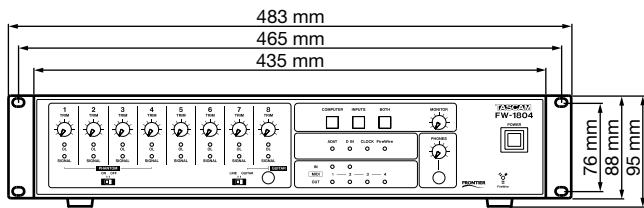

TASCAM

TEAC Professional Division

FW-1804

TEAC CORPORATION

Phone: +81-422-52-5082
3-7-3, Nakacho, Musashino-shi, Tokyo 180-8550, Japan

www.tascam.com

TEAC AMERICA, INC.

Phone: +1-323-726-0303
7733 Telegraph Road, Montebello, California 90640

www.tascam.com

TEAC CANADA LTD.

Phone: +1905-890-8008 Facsimile: +1905-890-9888
5939 Wallace Street, Mississauga, Ontario L4Z 1Z8, Canada

www.tascam.com

TEAC MEXICO, S.A. De C.V

Phone: +52-555-581-5500
Campesinos No. 184, Colonia Granjes Esmeralda, Delegacion Iztapalapa CP 09810, Mexico DF

www.tascam.com

TEAC UK LIMITED

Phone: +44-1923-438880
5 Marlin House, Croxley Business Park, Watford, Hertfordshire. WD1 8TE, U.K.

www.tascam.co.uk

TEAC EUROPE GmbH

Phone: +49-611-71580
Bahnstrasse 12, 65205 Wiesbaden-Erbenheim, Germany

www.tascam.de

TEAC FRANCE S. A.

Phone: +33-1-42-37-01-02
17 Rue Alexis-de-Tocqueville, CE 005 92182 Antony Cedex, France

www.tascam.fr

TEAC AUSTRALIA PTY.,LTD. A.B.N. 80 005 408 462

Phone: +61-3-9672-2400 Facsimile: +61-3-9672-2249
280 William Street, Port Melbourne, Victoria 3000, Australia

www.tascam.com.au

TEAC ITALIANA S.p.A.

Phone: +39-02-66010500
Via C. Cantu 11, 20092 Cinisello Balsamo, Milano, Italy

www.teac.it